



Stressless



himolla



GIUSEPPE NICOLETTI
Exclusively for HSL



HSL

Feel Good Furniture
Experts since 1968

Our partners in comfort.



himolla

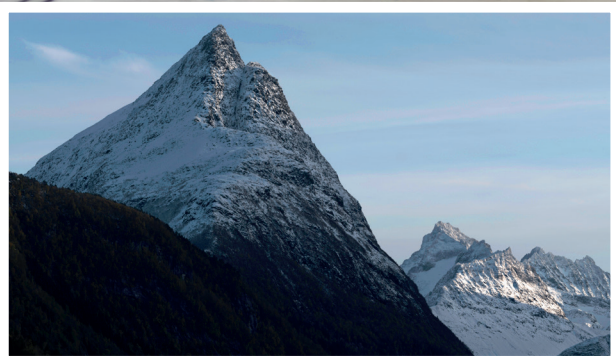

Scandinavian Design

HSL proudly presents our exclusive Stressless® Gallery Collection. Elevate your comfort with unparalleled back and posture support for ultimate relaxation.

Explore the full collection on page 4

German Innovation

By combining Himolla's heritage of innovation with HSL's focus on ergonomic comfort, we're proud to offer you the very best seating experience.

Explore the full collection on page 24



GIUSEPPE NICOLETTI
Esclusively for HSL



Italian Craftmanship

Experience the passion, tradition, and sophistication of Giuseppe Nicoletti sofas at HSL – where Italian luxury meets British comfort.

Explore the full collection on page 36

World Class Comfort

We're proud to partner with brands from around the world that are masters of their industry and share our passion for exceptional comfort, ergonomic design and outstanding craftsmanship.

The Gallery Collection

by



Exclusively at HSL

Opal Classic Base now available
on **3 Day Express Delivery****

from £1,199



Opal Signature Base delivered
within **7-14 working days.***

from £1,399



Wing Signature Base, shown in Paloma Copper.





50 years of exclusive comfort.

On the west coast of Norway, in the small community of Sykkylven, lies the company who has created some of the world's most comfortable chairs for generations – and still does.

In 1971, a revolutionary recliner was introduced and set a new standard in comfort and functionality. Stressless® was designed to offer maximum wellbeing and precious me-time in a busy, modern world. And with equal parts inspiration from nature and the region's tradition of skilled craftsmen, Stressless® got off to a flying start. Over 50 years later, Norway's largest furniture exporter is still located by the fjord and still offers you exclusive comfort, assembled by hand.

50 years of craftsmanship.

We aspire to create furniture with unparalleled comfort. With a highly skilled team of designers, engineers and skilled furniture makers we bring a fusion of expertise. Through collaboration, a design can surpass expectations. Comfort is one thing we never compromise on and we promise you'll appreciate the difference of how a genuine Stressless® feels.



Why Stressless®?

Take a seat and relax. When you do this in Stressless® furniture we hope you'll notice the difference between our furniture and everything else. The difference lies in our patented comfort technologies BalanceAdapt™. Power™. Plus™-system. Glide™-system.

Our vision is to create recliners and office chairs that provide perfect support while replicating the body's every movement. Add in the ability to select between three recliner sizes and the result is a level of fit and comfort one can only feel when spending time in Stressless® furniture.

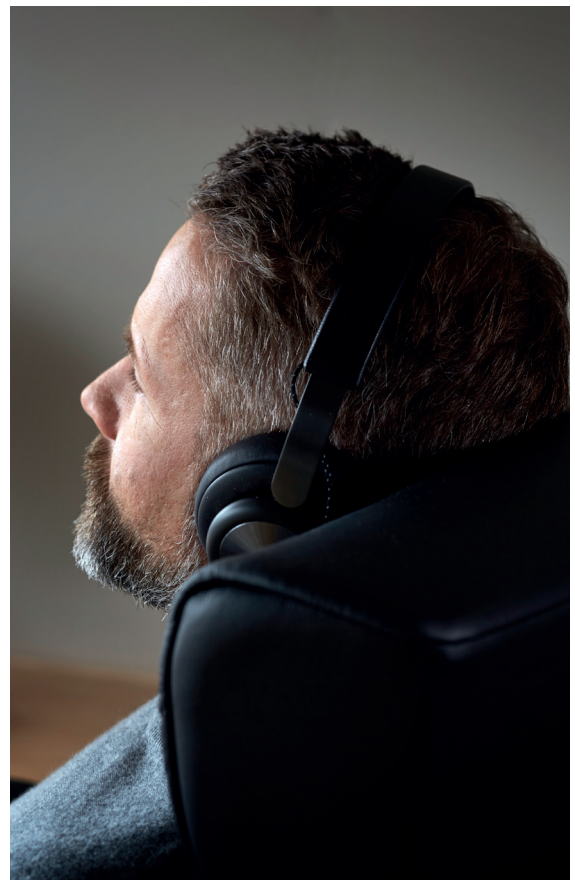



Ruby Classic Base, shown in Paloma Chocolate Brown.

Ruby



Base	Classic			Signature Available in Chrome or Black			Cross Available in Chrome or Black			Classic Power		Office
	(S)	(M)	(L)	(S)	(M)	(L)	(S)	(M)	(L)	(M)	(L)	(M)
Sizes (cm)	W: 74 H: 97-107 D: 74	W: 76 H: 98-108 D: 74	W: 88 H: 99-109 D: 77	W: 76 H: 100-110 D: 75	W: 78 H: 100-110 D: 76	W: 88 H: 101-111 D: 78	W: 76 H: 100-110 D: 75	W: 78 H: 100-110 D: 76	W: 88 H: 101-111 D: 78	W: 76 H: 98-108 D: 76-130	W: 88 H: 99-109 D: 77-131	W: 76 H: 108-115 D: 70
Fabric	£2,079	£2,239	£2,399	£2,429	£2,589	£2,749	£2,429	£2,589	£2,749	£3,014	£3,174	£1,921
Batick	£2,419	£2,599	£2,789	£2,769	£2,949	£3,139	£2,769	£2,949	£3,139	£3,374	£3,564	£2,202
Paloma	£2,589	£2,779	£2,979	£2,939	£3,129	£3,329	£2,939	£3,129	£3,329	£3,554	£3,754	£2,343
Velaro	£2,769	£2,969	£3,179	£3,119	£3,319	£3,529	£3,119	£3,319	£3,529	£3,744	£3,954	£2,491
Noblesse	£2,959	£3,169	£3,389	£3,309	£3,519	£3,739	£3,309	£3,519	£3,739	£3,944	£4,164	£2,647
Stool Size	W: 53 H: 38 D: 39			W: 53 H: 41 D: 39			W: 53 H: 41 D: 39					

All measurements are in cm. Sizes of individual products may vary by up to 3cm due to the handmade nature of the product.
The tested to weight is 20 stone for the Gallery Collection recliners.



Ruby Signature Base, shown in Paloma Copper.



Ruby Cross Base, shown in Paloma Sparrow Blue.

The Ruby

As the name suggests, the Stressless® Ruby will certainly be the most in-demand seating in the house.

With contours that are softly rounded, yet surprisingly sophisticated, the Ruby offers plush seating for any room. All Stressless comfort features are of course in place.



FIND YOUR BALANCE

With BalanceAdapt™. Subtle rocking motions enhance the feeling of total balance. Although subtle, these movements provide a fantastic feeling whilst seated.





Wing Classic Base, shown in Paloma Taupe.

Wing



Base	Classic			Signature Available in Chrome or Black			Cross Available in Chrome or Black			Classic Power		Office
	(S)	(M)	(L)	(S)	(M)	(L)	(S)	(M)	(L)	(M)	(L)	(M)
Sizes (cm)	W: 72 H: 96 D: 71	W: 76 H: 101 D: 71	W: 85 H: 102 D: 76	W: 80 H: 99 D: 71	W: 84 H: 103 D: 72	W: 93 H: 104 D: 78	W: 80 H: 99 D: 71	W: 84 H: 103 D: 72	W: 93 H: 104 D: 78	W: 76 H: 101 D: 74	W: 85 H: 102 D: 77	W: 76 H: 111-118 D: 72
Fabric	£1,879	£2,019	£2,169	£2,229	£2,369	£2,519	£2,229	£2,369	£2,519	£2,794	£2,944	£1,749
Batick	£2,189	£2,349	£2,519	£2,539	£2,699	£2,869	£2,539	£2,699	£2,869	£3,124	£3,294	£2,009
Paloma	£2,339	£2,509	£2,689	£2,689	£2,859	£3,039	£2,689	£2,859	£3,039	£3,284	£3,464	£2,129
Velaro	£2,499	£2,679	£2,869	£2,849	£3,029	£3,219	£2,849	£3,029	£3,219	£3,454	£3,644	£2,259
Noblesse	£2,669	£2,859	£3,059	£3,019	£3,209	£3,409	£3,019	£3,209	£3,409	£3,634	£3,834	£2,409
Stool Size	W: 54 H: 38 D: 38			W: 54 H: 41 D: 38			W: 54 H: 41 D: 38					

All measurements are in cm. Sizes of individual products may vary by up to 3cm due to the handmade nature of the product.
The tested to weight is 20 stone for the Gallery Collection recliners.



Wing Signature Base, shown in Paloma Chestnut.

The Wing

Luxurious with a modern look to those with a classic sense of style.

Behind the timeless surface lie top of the art mechanics and patents which provide what you've come to know as the one true Stressless[®] sitting experience.



Wing Cross Base, shown in Paloma New Cognac.



SUPPORT YOUR BACK

Whether you sit up or lie down, the Plus™ System provides optimal comfort and support for your head and lumbar region.





Opal Classic Base, shown in Paloma Dark Mushroom.

Opal



Base	Classic			Signature Available in Chrome or Black			Cross Available in Chrome or Black			Classic Power		Office
	(S)	(M)	(L)	(S)	(M)	(L)	(S)	(M)	(L)	(M)	(L)	(M)
Sizes (cm)	W: 74 H: 96 D: 71	W: 75 H: 100 D: 72	W: 90 H: 101 D: 72	W: 80 H: 99 D: 71	W: 84 H: 100 D: 71	W: 93 H: 100 D: 73	W: 80 H: 99 D: 71	W: 84 H: 100 D: 71	W: 93 H: 100 D: 73	W: 75 H: 100 D: 77-131	W: 84 H: 103 D: 79-132	W: 75 H: 110-117 D: 66
Fabric	£1,539	£1,659	£1,939	£1,889	£2,009	£2,289	£1,889	£2,009	£2,289	£2,434	£2,714	£1,469
Batick	£1,799	£1,939	£2,259	£2,149	£2,289	£2,609	£2,149	£2,289	£2,609	£2,714	£3,034	£1,687
Paloma	£1,929	£2,079	£2,419	£2,279	£2,429	£2,769	£2,279	£2,429	£2,769	£2,854	£3,194	£1,797
Velaro	£2,069	£2,219	£2,589	£2,419	£2,569	£2,939	£2,419	£2,569	£2,939	£2,994	£3,364	£1,906
Noblesse	£2,209	£2,369	£2,769	£2,559	£2,719	£3,119	£2,559	£2,719	£3,119	£3,144	£3,544	£2,023
Stool Size	W: 54 H: 39 D: 40			W: 54 H: 41 D: 40			W: 54 H: 41 D: 40					

All measurements are in cm. Sizes of individual products may vary by up to 3cm due to the handmade nature of the product.
The tested to weight is 20 stone for the Gallery Collection recliners.



Opal Signature Base, shown in Paloma Chestnut.

The Opal

The Opal has a modern, comfortable and fashionable look, that invites you in to fully relax.

Stressless® Opal boasts all the same renowned comfort features for which Stressless® is famous.



Opal Cross Base, shown in Batick Black.



Quickship Stressless® Opal Recliners delivered within **3-14 working days.***

from £1,199

Find out more on page 14





Quickship Stressless® Opal delivered within **3-14 working days***

Classic Base now available on 3 Day Express Delivery **



Opal Signature, shown in Batick Dove and Oak Wood Finish

Signature Base and Footstool

Available in:



Batick Cream
Oak Wood



Batick Dove
Oak Wood



Batick Mole
Walnut Wood

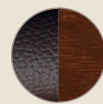

Batick Brown
Brown Wood

RRP £2,149

(S) £1,399

RRP £2,289

(M) £1,499

RRP £2,609

(L) £1,599



Opal Classic, shown in Batick Mole and Walnut Wood Finish

Classic Base and Footstool

Available in:



Batick Cream
Oak Wood



Batick Dove
Oak Wood



Batick Mole
Walnut Wood

RRP £1,799

(S) £1,199

RRP £1,939

(M) £1,299

RRP £2,259

(L) £1,399

Now available on



Express Delivery**



Office Chair, shown in Batick Black and Black Finish

Office Chair

Available in:

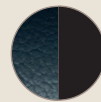

Batick Black
Black Metal

RRP £1,687

(M) £1,299

*Prices shown are exclusive to the Stressless® Quickship range and cannot be used in conjunction with any other offer, sale, discount, promotion or voucher. Quickship Delivery only available on the selected products shown - ready to deliver within 14 working days. Orders received before 12pm Monday to Thursday will be delivered in 14 working days. Postcode restrictions apply, ask in-store or visit hslchairs.com for details. All items are whilst stocks last. **Ready to deliver within 3 working days. Orders received before 12pm Monday to Thursday will be delivered in 3 working days. Postcode restrictions apply, ask in-store or visit hslchairs.com for more details. The delivery charge is £65 plus VAT where applicable.



Premium leather in a choice of colours and textures.

Being one of the world's largest premium furniture manufacturers comes with responsibility.

All our leather is manufactured in keeping with current laws and guidelines for animal welfare, health, safety and the environment.

Here, we work alongside recognised international institutions to ensure that we are always up-to-date. Our inspectors also take part in the leather selection process from our chosen tanneries. We maintain the highest of standards, so that you always make a great choice – regardless of texture, softness, colour and how you want the leather to look and feel.

For this, we offer many types of leather – from the most exclusive and delicate to the more robust quality.



Stressless® offers three categories of leather in a selection of beautiful colours

Ask in-store to discover the full Stressless® Leather Collection

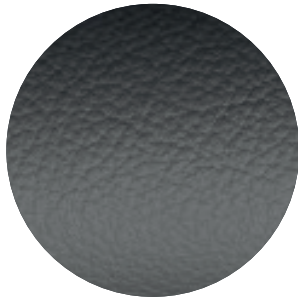

Paloma

Slightly corrected leather with a combination of dyes and pigments that smooths down some of the structure (the grain pattern) of the leather.

The grain structure in Paloma may, however, vary a little at some parts of the furniture and also minor colour nuances may appear in the leather. Natural marks, scars and insect bites are natural and will appear in Paloma.



Batick

Corrected, pigment-improved and grain-embossed upholstery leather, which has had most of its natural marks removed.

Batick may have a two-tone colour effect to liven up the surface. Batick is resistant to fading, although changes in colour will occur over time due to use and exposure to light.



Velaro

Velaro is a thick, full-bodied leather with an elegant grain and natural look. It is dyed through, with a natural surface that is only slightly corrected and lightly coated. A double-tone and slight tip shine effect, add both depth and brightness to the shades. The very light embossing on Velaro mitigates the grain variation along the leather's surface, but some variations in grain pattern and colour nuances should be expected. Although robust, this leather remains very soft and sumptuous to the touch.

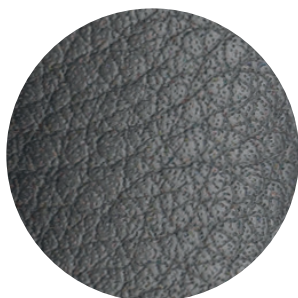

Noblesse

The most exclusive leather in the Stressless® collection. It is a full grain, semi-aniline leather, which means that the leather is dyed using a light surface treatment.

This provides a certain amount of protection, while maintaining the natural softness and glow that are characteristic of a first class upholstery leather.



Wing Power Base, shown in Calido Brown Fabric

Sustainable fabrics, inspired by nature.

The Stressless® fabric collection offers you the possibility of creating a calm breathing space in the comfort of your own home. We have a large selection of qualities and colours to choose from.

Our specially selected fabric collection meets the furniture industry's strictest requirements. Stressless® fabrics are produced in accordance with strict environmental conditions and are treated for heavy-duty use, light tolerance and inflammability.



Peony

70% Wool, 30% Viscose.

Classic wool fabric available in soft neutral colours. The small herringbone pattern provides a classic yet modern look, creating a warm atmosphere with a sense of quality and timeless design. The natural wool yarn makes the fabric strong.

Calido

80% Wool, 20% Polyamide.

Wool felt fabric with an exclusive appearance, which feels comfortable and soft next-to-the skin. It is available in a varied and exclusive colour palette.

Clover

70% Wool, 30% Viscose.

Classic wool fabric with a modern design and a beautiful calm colour palette. The smooth, soft surface is enhanced by the subdued colours with a melange effect, creating a fabric with distinct character. It is manufactured at a renowned Norwegian weaving mill with long traditions.

Yoredale

95% Wool, 3% Polyester, 2% Polyamide.

Structured wool fabric with a modern range of colors. The fabric feels soft and cosy and it is perfect for creating a classic, warm and inviting interior. It is available in a varied and exclusive colour palette.

NEW

Abelia

96% Wool, 4% Polyamide.

Abelia is a luxurious wool blend, woven with different yarn types to offer a finish with depth and structure. The 96% wool content provides many benefits, including being renewable and biodegradable as well as naturally warm, hypoallergenic and odour and stain resistant. Ensuring a long-lasting, enduring style.

NEW

Holly

45% GRS Certified Recycled Wool, 30% GRS Certified Recycled Cotton

With its natural look, the Holly fabric is made out of old wool garments that are recycled and made into new fabrics, reducing the use of virgin material. Furthermore, it promotes the virtues of balance and slowing down, tapping into the wellness effect for interiors that soothe the soul with timeless, luxury appeal.



Stressless® Leather and Fabric Care kits.

See page 18 for more information on our leather and fabric care kits.

How to build your perfect Stressless® chair

Select design and size

Optimal comfort is also about the correct size. Most of our recliners are available in up to three sizes for you to find the perfect fit.



Select upholstery in leather or fabric

Stressless® furniture can be delivered in numerous covers: 4 leather qualities and 6 fabric qualities in more than 100 colours.

Select base in wood or metal

There are five different bases to choose from, all with one thing in common; unique comfort.



Signature Base with BalanceAdapt™

An elegant combination of wood and aluminium that offers a soft and comfortable rocking motion.

Available in sizes S, M and L.



Cross Base with BalanceAdapt™

An elegant combination of wood and aluminium that offers a soft and comfortable rocking motion.

Available in sizes S, M and L.



Classic Base

A timeless design in classic wood with unique stability.

Available in sizes S, M and L.



Classic Power™ Base

The comfortable Power system is elegantly concealed beneath the seat, but subtly concealed controls extend the integrated footstool providing the perfect support for your legs.

Available in sizes M and L.



Home Office Base

This castor base offers full freedom of movement and height adjustment for personal adaption of your seat height.

Available in size M.



Stressless® Footstool

A separate footstool with angle adjustments allows for maximum freedom of position according to your body size.

Available as standard with all recliners excluding the Classic Power™ Base

ACCESSORIES

Hard Floor Protector

Self-adhesive felt for use under the base as floor protection.



£11.99

Elevator Ring

The Stressless® elevator ring adds an extra 3.5 cm sitting height, and is your key to comfort if you need extra height. Just snap it on: no tools are required.



S £99 M £109 L £119

Signature Elevator Kit

If you require additional height on your Stressless® with a Signature base you can order an elevator kit, which is easily attached and will increase the height of your chair by 3.5cm.



£79

Footstool Elevator Ring

The Stressless® footstool elevator ring adds 3.5 cm to the height.



£79

TABLES

Swing Table

This table remains independent of your movements and can be simply swung aside when not in use. Can only be fitted to Classic base and Power recliners.



W: 28cm

£99

Ellipse Table (Adjustable height)

This flexible, easy-to-move table is ideal, since it keeps everything you need within easy reach while you are in your "comfort zone".



W: 49cm D: 38cm H: 48-71cm

£269

Stressless® wood colours.

Ekornes uses rotary cut beech veneer in all its moulded furniture components. Lightly steamed beech is used for solid wood components.

The hardness of the wood makes beech furniture extremely durable, and the timber we use is a renewable resource. Beech is a natural material and variations in its pattern, colour and texture make each piece of furniture unique.

Although beech is used for both solid and moulded components, structural differences may be visible.



Stressless® Leather and Fabric Care kits.



Ekornes offers its own leather and fabric (including microfibre) care kits to match the high quality of our furniture.

The Stressless® Leather Care kit (medium/large) contains a leather cleaner and protection cream. Stressless® Leather Care Wipes® are also available.

For maintenance, and to make the leather more resistant to stains, the protective cream should be applied to all your recliner's leather surfaces when new. We recommend that you clean the leather with Stressless® leather cleaner at least once every six months to keep your leather looking its best, removing stains regularly and ensuring long leather life. Always apply the protective cream after cleaning.

The Stressless® Fabric Care kit contains a fabric cleaner, a stain remover and an Ox cleaner. This kit contains everything you need to clean your furniture in minutes without removing the fabric cover. For resistant stains, use the fabric cleaner together with the stain remover and Ox cleaner.

These are the only cleaning products recommended by Stressless®. Stressless® accepts no responsibility if cleaning products other than those recommended by Ekornes are used and cause damage to the leather.

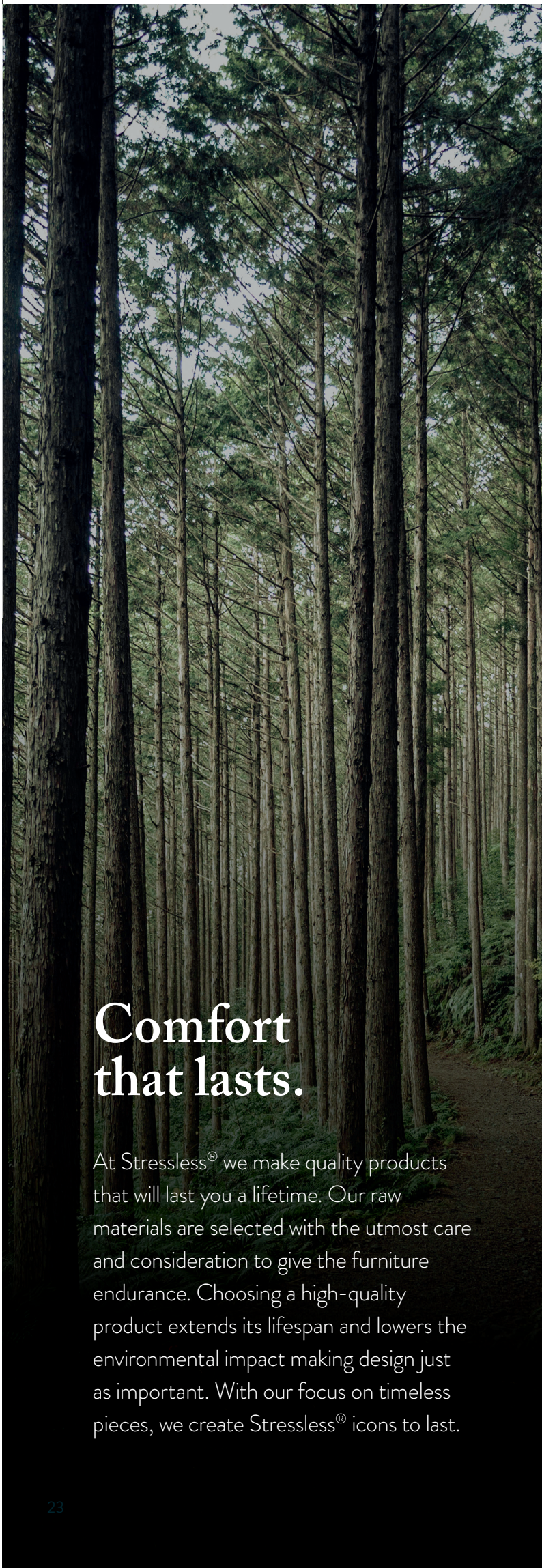

Comfort that lasts.

At Stressless® we make quality products that will last you a lifetime. Our raw materials are selected with the utmost care and consideration to give the furniture endurance. Choosing a high-quality product extends its lifespan and lowers the environmental impact making design just as important. With our focus on timeless pieces, we create Stressless® icons to last.

5
YEAR GUARANTEE

We guarantee all electrical parts and motor on the Power™ system for a period of 5 years from the date of initial delivery to the consumer. The battery is not included in the 5-year guarantee.

2 YEAR GUARANTEE on Power Batteries.

10
YEAR GUARANTEE

10-year internal mechanism & construction guarantee

We guarantee the internal mechanism and construction of our recliners for a period of 10 years from the date of initial delivery to the consumer. The 10-year guarantee covers the mechanical functions in the recliner. The 10-year guarantee covers the internal framework of steel and/or wood, including the metal springs.

The 10-year guarantee does not cover damage to leather, woodwork or any faults or damage caused by the use of the product other than in accordance with the manufacturer's recommendations, as well as any faults or damage arising from any repairs made by any persons not authorized by the manufacturer or use of non-original parts. Some natural settlement and indentation in the padding and foam is considered normal and is part of a break-in process.

THE
himolla
COLLECTION



20%

off RRP

Limited Time
Only



himolla

The ultimate in functionality for perfect relaxation

Available in sizes to fit you

Guaranteed for 5 years

Available in selected HSL showrooms only

Call 01924 507050 to check availability,
scan the QR code to find your local showroom.





Quality from Bavaria

Himolla has earned a global reputation for exceptional craftsmanship. With over 60 years of experience, they share HSL's commitment to comfort, quality, and attention to detail.

This partnership allows us to bring you expertly designed, supremely comfortable recliners like the Sinatra, crafted to meet the highest standards. By combining Himolla's heritage of innovation with HSL's focus on ergonomic comfort, we're proud to offer you the very best seating experience.

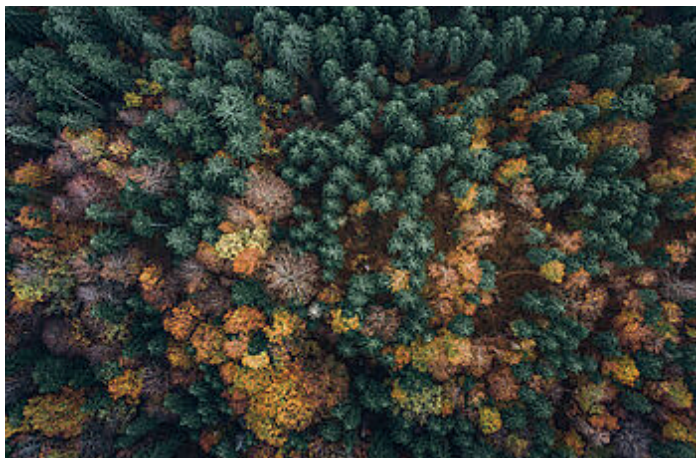

Sustainability

Protecting the environment and using resources wisely has always been a priority for Himolla, ensuring that you can enjoy the highest-quality furniture while making eco-conscious choices.



Sizes to fit you

Himolla's ergonomically engineered riser recliners are available in up to 7 sizes to ensure a perfect fit and ultimate support for your neck, back and hips.



Himolla's Five Year Warranty

- All long-life leathers and most fabrics
- Foam
- Frames

The Sinatra Swivel

Sit upright, recline, rise or lie down with ease with the Sinatra Swivel from Himolla. Perfect for reading, relaxing in front of the TV or even sleeping.

Superior
head and
arm support

Ergonomic
design

Wireless
Battery
Option
Available

360° swivel action



10-12 WEEK DELIVERY



Available in four sizes to fit your body, from Petite to Super Grande

Lift and rise function available

Independently adjustable backrest and leg rest

Choose from manual or electric reclining

Customisable motion features

VAT FREE ELIGIBLE



Introducing Our First Swivel Rise and Recline Chair

Available in 4 Sizes



Petite



Standard



Grande



Super Grande



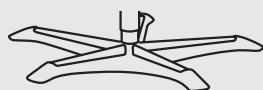

The finishing touches

Choose from a variety of base options, including a star base or a round swivel base in beechwood or stainless steel, and customise your chair with a wide range of durable fabric or leathers in various colours.

ROUND BASE OPTIONS



Wooden Base

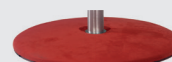

Covered Base

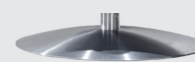

Stainless Steel



Anthracite Powder Coat



Wooden Base with Stainless Steel Ring

STAR-SHAPED BASE OPTIONS

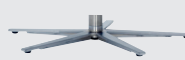

Stainless Steel



Anthracite Powder Coat



Bronze Powder Coat

SINATRA SWIVEL PRICING	FROM PRICES*	
	FABRIC	LEATHER
Manual Recliner RRP	£2,594	£2,739
Manual Recliner - 20% OFF	£2,076	£2,192
Electro 2-Motors Recliner RRP	£3,020	£3,168
Electro 2-Motors Recliner - 20% OFF	£2,416	£2,535
Electro 3-Motors Recliner RRP	£3,183	£3,333
Electro 3-Motors Recliner - 20% OFF	£2,547	£2,667
Lift & Rise 2-Motors Recliner RRP	£3,213	£3,336
Lift & Rise 2-Motors Recliner - 20% OFF	£2,571	£2,669
Lift & Rise 3-Motors Recliner RRP	£3,349	£3,472
Lift & Rise 3-Motors Recliner - 20% OFF	£2,680	£2,778
HD Lift & Rise Chair RRP	£3,464	£3,587
HD Lift & Rise Chair - 20% OFF	£2,772	£2,870

VAT FREE[^] price shown for eligible customers, ask for more details.

ACCESSORIES AND ADDITIONAL OPTIONS AVAILABLE

Prices available upon request. Ask a Comfort Expert for more details.

DIMENSIONS	DIMENSIONS W/D/H (CM)	SEAT HEIGHT (CM)	SEAT DEPTH (CM)	SEAT WIDTHS (CM)
MANUAL/ELECTRO/LIFT & RISE				
Petite	82/88/107	44	52	50
Standard	82/90/109	46	54	50
Grande	82/92/113	50	56	50
Super Grande	82/96/118	52	58	50
HD LIFT & RISE 3-MOTORS RECLINER				
Lift & Rise Chair	87/84/116	47	54	58

*Other fabrics/leather band choices available, prices available on request. [^]VAT Free for eligible customers, ask for details.

Exclusively at HSL

THE

Alpha

The Alpha range offers ergonomic comfort, designed to provide the best level of support at every sitting and lying position.

Independent functionality on the neckrest, backrest and footrest



Available in six sizes to fit your body, from Super Petite to Super Grande

Battery powered & cable-free

A wide range of fabrics and leathers

10-12 WEEK DELIVERY



Uniquely shaped foam that enhances overall comfort



Heart-Balance function on selected models for optimal support



Lift & Rise Recliner

The unique functionality of the range, with independent function or the neckrest, backrest and footrest promote a cradled sitting position, giving you the support where you need it most.

Wallhugger Fixed or Recliner Sofa

Choose from a traditional fixed Wallhugger Sofa or upgrade to a recliner with the Heart-Balance function, saving you space behind your furniture while simultaneously giving you the most comfortable position with this mechanism.



Heart Balance Function

The 'Heart Balance' recline function raises the footrest higher than your heart when fully reclined, to help improve circulation and wellbeing. With its superior comfort features, personalised adjustments, and modern design, this recliner allows you to unwind and recharge in luxurious comfort.

FROM PRICES*

ALPHA PRICING	FABRIC	LEATHER
2 Seater Alpha Fixed Sofa RRP	£3,149	£3,546
2 Seater Alpha Fixed Sofa - 20% OFF	£2,520	£2,837
2.5 Seater Alpha Fixed Sofa RRP	£3,370	£3,767
2.5 Seater Alpha Fixed Sofa - 20% OFF	£2,696	£3,014
3 Seater Alpha Fixed Sofa RRP	£4,040	£4,572
3 Seater Alpha Fixed Sofa - 20% OFF	£3,232	£3,658
2 Seater Alpha Manual Recliner Sofa RRP	£3,618	£3,980
2 Seater Alpha Manual Recliner Sofa - 20% OFF	£2,895	£3,184
2.5 Seater Alpha Manual Recliner Sofa RRP	£3,834	£4,269
2.5 Seater Alpha Manual Recliner Sofa - 20% OFF	£3,068	£3,416
3 Seater Alpha Manual Recliner Sofa RRP	£5,022	£5,525
3 Seater Alpha Manual Recliner Sofa - 20% OFF	£4,018	£4,420
2 Seater Alpha Power Recliner Sofa RRP	£5,079	£5,441
2 Seater Alpha Power Recliner Sofa - 20% OFF	£4,064	£4,353
2.5 Seater Alpha Power Recliner Sofa RRP	£5,295	£5,730
2.5 Seater Alpha Power Recliner Sofa - 20% OFF	£4,236	£4,584
2 Seater Wall Hugger Manual Recliner Sofa RRP	£3,942	£4,304
2 Seater Wall Hugger Manual Recliner Sofa - 20% OFF	£3,154	£3,444
2.5 Seater Wall Hugger Manual Recliner Sofa RRP	£4,158	£4,593
2.5 Seater Wall Hugger Manual Recliner Sofa - 20% OFF	£3,327	£3,675
3 Seater Wall Hugger Manual Recliner Sofa RRP	£4,512	£4,982
3 Seater Wall Hugger Manual Recliner Sofa - 20% OFF	£3,610	£3,986
2 Seater Wall Hugger Power Recliner Sofa RRP	£5,400	£5,765
2 Seater Wall Hugger Power Recliner Sofa - 20% OFF	£4,320	£4,612
2.5 Seater Wall Hugger Power Recliner Sofa RRP	£5,616	£6,054
2.5 Seater Wall Hugger Power Recliner Sofa - 20% OFF	£4,493	£4,844
3 Seater Wall Hugger Power Recliner Sofa RRP	£5,973	£6,443
3 Seater Wall Hugger Power Recliner Sofa - 20% OFF	£4,779	£5,155
Lift & Rise 3-Motors Recliner Standard Leg Rest RRP	£2,979**	£3,276**
Lift & Rise 3-Motors Recliner Standard Leg Rest - 20% OFF	£2,384**	£2,621**
Lift & Rise 3-Motors Recliner Extended Leg Rest RRP	£3,037**	£3,335**
Lift & Rise 3-Motors Recliner Extended Leg Rest - 20% OFF	£2,430**	£2,668**
Lift & Rise 3-Motors Recliner Standard Leg Rest & Heart Balance RRP	£3,004**	£3,294**
Lift & Rise 3-Motors Recliner Standard Leg Rest & Heart Balance - 20% OFF	£2,404**	£2,636**
Lift & Rise 3-Motors Recliner Extended Leg Rest & Heart Balance RRP	£3,062**	£3,352**
Lift & Rise 3-Motors Recliner Extended Leg Rest & Heart Balance - 20% OFF	£2,450**	£2,682**

VAT FREE[^] price shown for eligible customers, ask for more details.

DIMENSIONS	DIMENSIONS W/D/H (CM)	SEAT HEIGHT (CM)	SEAT DEPTH (CM)	SEAT WIDTHS (CM)
ALPHA LIFT AND RISE (ALL MODELS)				
Super Petite	72/88/107	43	50	Standard: 47/ Wide:51
Petite	72/88/109	45	50	Standard: 47/ Wide:51
Standard	72/88/111	47	50	Standard: 47/ Wide:51
Standard Plus	72/91/113	46	54	Standard: 47/ Wide:51
Grande	72/91/115	48	54	Standard: 47/ Wide:51
Super Grande	72/91/117	50	54	Standard: 47/ Wide:51
ALPHA SOFA (ALL MODELS)				
2 Seater	150/92/107	44	52	n/a
2.5 Seater	170/92/107	44	52	n/a
3 Seater	207/92/107	44	52	n/a

*Other fabrics/leather band choices available, prices available on request. **Prices are based on Super Petite/Petite/Standard and Standard width. Other sizes available, prices available on request. ^VAT Free for eligible customers, ask for details.



GIUSEPPE NICOLETTI
Exclusively for HSL



HANDCRAFTED IN ITALY



Modern style, traditional family values.

Discover the beauty and craftsmanship of Giuseppe Nicoletti furniture, now available exclusively at HSL. With a rich heritage dating back decades, Giuseppe Nicoletti and his sons have crafted the finest upholstered furniture, echoing the same family dedication we hold dear at HSL.



At Nicoletti, trained artisans meticulously design and develop each collection, blending years of expertise with advanced technology to refine the perfect seating experience.

Their designs allow you to create endless configurations, tailored to fit the unique needs and style of your home, making each piece distinctly yours. Experience enhanced seating with adjustable headrests and reclining options, designed to elevate your relaxation and make every moment a true pleasure.

Together, we have guaranteed that with this latest collection, whatever your style, you'll find the ideal piece for your home.

Experience the passion, tradition, and sophistication of Giuseppe Nicoletti sofas at HSL – where Italian luxury meets British comfort.



Built around your lifestyle

The collections offer a variety of options, including a chair, 2-seater, and 3-seater sofa, as well as modular pieces allowing you to add various pieces to create the perfect configuration, tailored to your space, with each section delivered as an individual piece.



Discover true luxury with our fabric and leather collections.

Our luxurious collections of fabrics and leathers are hand-selected by our design teams to perfectly complement your chosen piece. From natural leather hides to our super-soft fabrics designed to withstand daily use while maintaining their beauty, each material ensures your Nicoletti furniture remains a centrepiece of style and relaxation in your home.

Torello Leather

This quality family-friendly leather, has a soft corrected textured grain, giving it a uniform yet natural appearance.

Created in the finest Italian tanneries it is around 20% thicker than most standard leathers on the market. Boasting a protective finish across a wide range of fashionable colours makes it ideal for busy family life.

Botero Leather

This beautiful semi aniline through dyed leather offers a wonderful natural grain, lightly buffed to ensure a soft silk like handle to this natural leather. Also available in a wide range of fashionable colours, this luxury leather tailors beautifully on our exclusive Italian collections.

Like all leathers these articles show the natural characteristics and variations in colour and grain, making each piece truly unique and are the hallmark of its natural authenticity.



**Adjustable headrest
offering maximum
comfort**



Lucca Power Recliner Sofa and Chair in Torello Blue.



**Seamless button control
with charging ports**

Lucca

Lucca, a firm favourite of our in-house design team, is a masterpiece of comfort and style. Choose the power recliner design, and with just a press of a button, fine-tune the headrests and adjustable lumbar support millimetre by millimetre until you achieve that perfect, weightless feeling.

Upholstered in 100% premium quality leather from Italian tanneries, with exquisite hand-stitching and a beautifully simple silhouette, the Lucca exudes quality from every angle. Exclusively available at HSL.

	Fabric	Torello Leather	Botero Leather
Static			
Chair	£1,185	£1,485	£1,685
2 Seater Sofa	£1,720	£2,020	£2,220
3 Seater Sofa (2 Seat Cushions)	£2,050	£2,350	£2,550
Power Recliner			
Chair	£1,390	£1,690	£1,890
2 Seater Sofa	£2,495	£2,795	£2,995
3 Seater Sofa (2 Seat Cushions)	£2,850	£3,150	£3,350
Dual Motor Power Recliner (Adjustable Head and Leg)			
Chair	£1,555	£1,855	£2,055
2 Seater Sofa	£2,820	£3,120	£3,320
3 Seater Sofa (2 Seat Cushions)	£3,185	£3,485	£3,685
Dual Motor Power Recliner (Adjustable Head, Leg and Lumbar)			
Chair	£1,610	£1,910	£2,110
2 Seater Sofa	£2,935	£3,235	£3,435
3 Seater Sofa (2 Seat Cushions)	£3,295	£3,595	£3,795



Lucca Dual Motor Power Recliner (Adjustable Head, Leg and Lumbar) range in Torello Blue Leather delivered within **7-14 working days.***

Modular Extras			
Armless Unit (Static or Power)	£770	£1,070	£1,270
Static Arm Unit LHF/RHF	£970	£1,270	£1,470
Power Recliner Arm Unit LHF/RHF	£1,250	£1,550	£1,750

Dimensions (cm)	H	W	D	Seat Height	Seat Depth
Static/Power Recliner and Dual Motor Power Recliner					
Chair	103	104	100	48	52
2 Seater Sofa	103	165	100	48	52
3 Seater Sofa (2 Seat Cushions)	103	200	100	48	52
Modular Extras					
Armless Unit (Static or Power)	103	61	100	48	52
Static Arm Unit LHF/RHF	103	83	100	48	52
Power Recliner Arm Unit LHF/RHF	103	83	100	48	52

Please allow for a minimum tolerance of +/-3 cm on each dimension.

The Collection

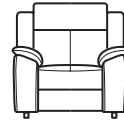

Chair

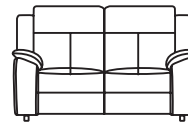

2 Seater

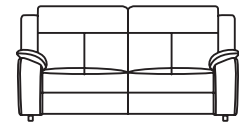

3 Seater

Modular Units

Power Recliner Arm Unit
103 H | 83 W | 100 D

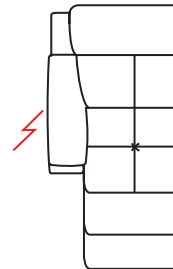

Armless Unit (Static or Power)
103 H | 61 W | 100 D

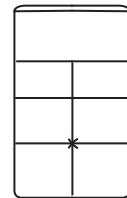

Static Arm Unit
103 H | 83 W | 100 D

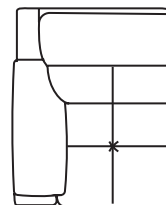

*Quickship Delivery only available on the selected products shown - ready to deliver within 14 working days. Orders received before 12pm Monday to Thursday will be delivered in 14 working days. Postcode restrictions apply, ask in-store or visit hslchairs.com for details. All items are whilst stocks last.



Elegant sweeping curves

Slender sculpted legs

Modena Modular Power Recliner Chaise End Sofa in Torello Ice. Scatters in Inari Dove.



Seamless button control with charging ports

Modena Power Recliner Chair in Baobab Ecu.

Modena

Introducing Modena, elegantly designed with sweeping curves, slender metal legs, and sophisticated stitching detail throughout the backs and seats, embodying a refined European aesthetic.



Ergonomically designed to provide exceptional comfort



Chair

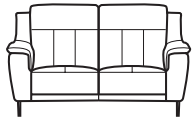

2 Seater

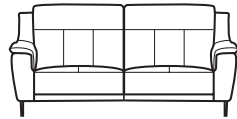

3 Seater

Modular Units

Static/Power Arm Unit
100 H | 83 W | 97 D

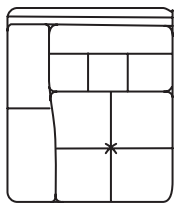

Armless Unit
100 H | 58 W | 97 D

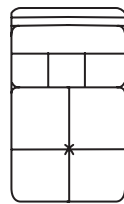

Corner Unit
100 H | 104 W | 104 D

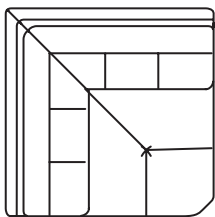

Ottoman End Unit
100 H | 210 W | 104 D

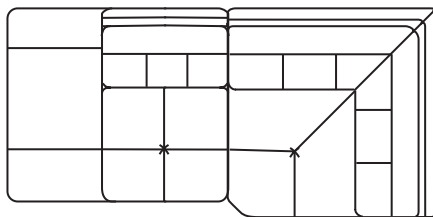

Also available as a right-hand corner configuration.
Other sizes available, please speak to an in-store colleague.

	Fabric	Torello Leather	Botero Leather
Static			
Chair	£1,305	£1,605	£1,805
2 Seater Sofa	£1,960	£2,260	£2,460
3 Seater Sofa (2 Seat Cushions)	£2,195	£2,495	£2,695
Corner Sofa (4 Seats) LHF/RHF	£3,650	£3,950	£4,150
Power Recliner			
Chair	£1,800	£2,100	£2,300
2 Seater Sofa	£3,035	£3,335	£3,535
3 Seater Sofa (2 Seat Cushions)	£3,185	£3,485	£3,685
Corner Sofa (4 Seats) LHF/RHF	£4,440	£4,740	£4,940
Modular (Midi-size)			
Static Arm Unit LHF/RHF	£925	£1,225	£1,425
Power Recliner Arm Unit LHF/RHF	£1,320	£1,620	£1,820
Armless Unit	£755	£1,055	£1,255
Corner Unit	£1,060	£1,360	£1,560
Ottoman End Unit LHF/RHF	£2,030	£2,330	£2,530

Our Popular Modular Configurations

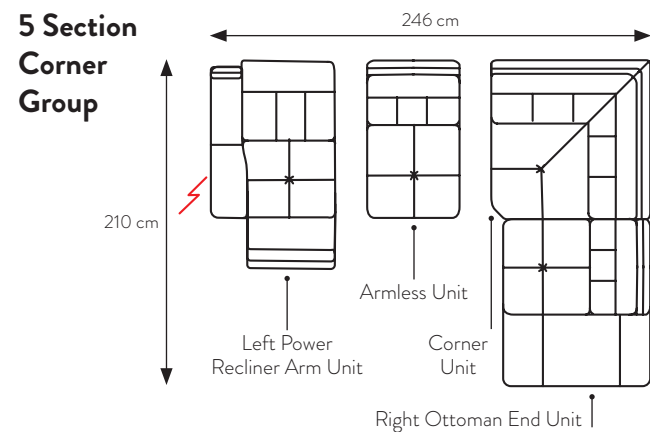
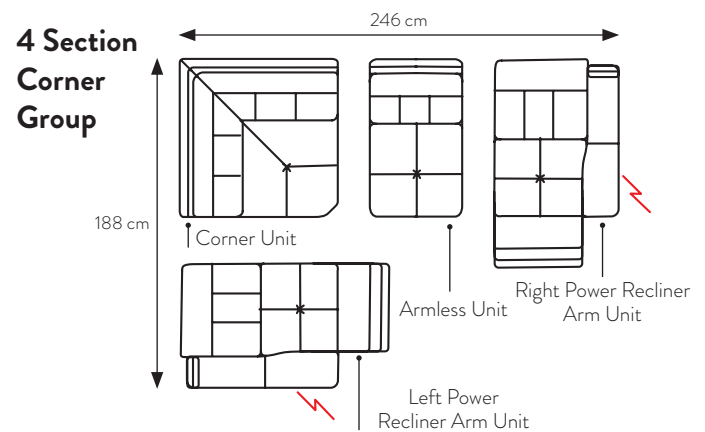
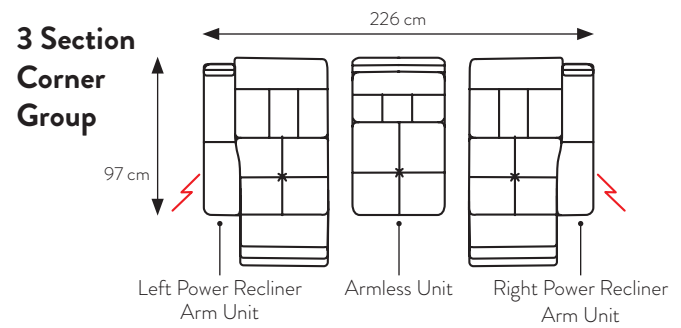

Dimensions (cm)	H	W	D	Seat Height	Seat Depth
Static/Power Recliner					
Chair	100	108	97	44	54
2 Seater Sofa	100	165	97	44	54
3 Seater Sofa (2 Seat Cushions)	100	203	97	44	54
Corner Sofa (4 Seats) LHF/RHF	100	246	188	44	54
Modular					
Static Arm Unit LHF/RHF	100	83	97	44	54
Power Recliner Arm Unit LHF/RHF	100	84	97	44	54
Armless Unit	100	58	97	44	54
Corner Unit	100	104	104	44	54
Ottoman End Unit LHF/RHF	100	210	104	44	54

Please allow for a minimum tolerance of +/-3 cm on each dimension.

On display in selected showrooms, please call your local store to check for availability.

Portofino

Discover modern harmony with Portofino: where sleek design meets advanced technology.

Enjoy adjustable headrests, elegant metal inserts, and convenient USB connectivity. Portofino's modular design allows you to create the perfect piece for your home.



Fully adjustable
powered headrest

Elegant metal
insert detailing

Portofino Power Recliner Chaise End Sofa in Botero Cream.



Chair

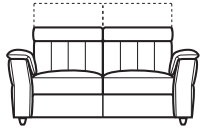

2 Seater

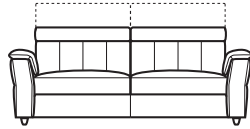

3 Seater

Modular Units

Static/Power Arm Unit
84 H | 84 W | 98 D

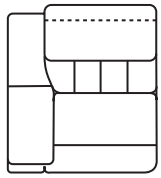

Armless Unit
84 H | 62 W | 98 D

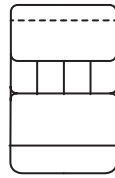

Corner Unit
84 H | 105 W | 105 D

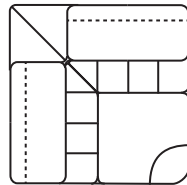

Chaise End Unit
84 H | 101 W | 158 D

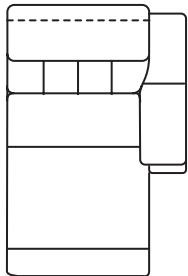

Ottoman End Unit
84 H | 235 W | 105 D

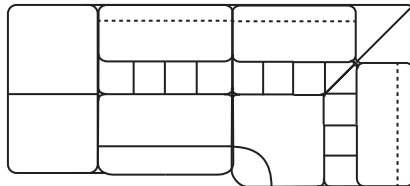

Also available as a right-hand corner configuration.
Other sizes available, please speak to an in-store colleague.

	Fabric	Torello Leather	Botero Leather
Static			
Chair	£1,310	£1,610	£1,810
2 Seater Sofa	£1,915	£2,215	£2,415
3 Seater Sofa (2 Cushions)	£2,085	£2,385	£2,585
Corner Sofa (4 Seats) LHF/RHF	£3,930	£4,230	£4,430
Power Recliner with Power Headrest			
Chair	£1,650	£1,950	£2,150
2 Seater Sofa	£2,815	£3,115	£3,315
3 Seater Sofa (2 Cushions)	£2,965	£3,265	£3,465
Corner Sofa (4 Seats) LHF/RHF	£4,575	£4,875	£5,075
Modular (Midi-size)			
Static Arm Unit LHF/RHF	£1,055	£1,355	£1,555
Power Recliner Arm Unit LHF/RHF	£1,410	£1,710	£1,910
Armless Unit	£850	£1,150	£1,350
Corner Unit	£1,375	£1,675	£1,875
Chaise Lounge Unit LHF/RHF	£1,650	£1,950	£2,150
Ottoman End Unit LHF/RHF	£2,465	£2,765	£2,965

Our Popular Modular Configurations

4 Section Corner Group

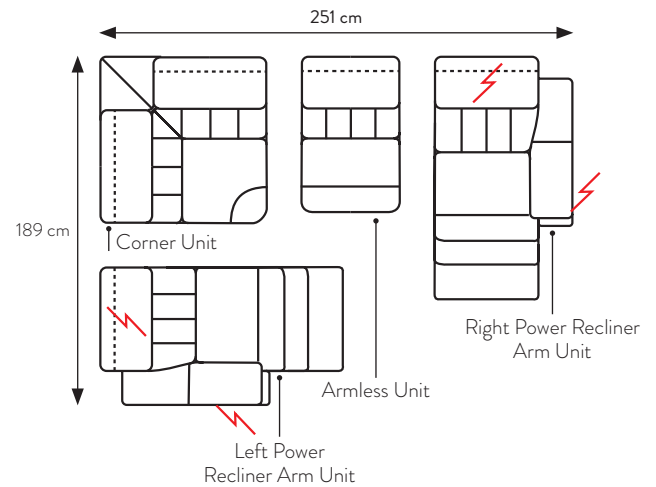

5 Section Corner Group

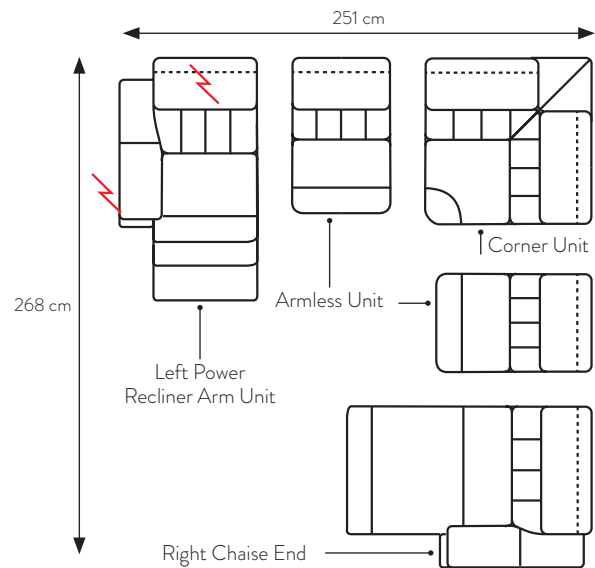

Dimensions (cm)	H	W	D	Seat Height	Seat Depth
Static with Manual Headrest/Power Recliner with Power Headrest					
Chair	84	112	98	47	52
2 Seater Sofa	84	167	98	47	52
3 Seater Sofa (2 Seat Cushions)	84	202	98	47	52
Corner Sofa (4 Seats) LHF/RHF	84	251	189	47	52
Modular					
Static Arm Unit LHF/RHF	84	84	98	47	52
Power Recliner Arm Unit LHF/RHF	84	84	98	47	52
Armless Unit	84	62	98	47	52
Corner Unit	84	105	105	47	52
Chaise End Unit LHF/RHF	84	101	158	47	52
Ottoman End Unit LHF/RHF	84	235	105	47	52

Please allow for a minimum tolerance of +/-3 cm on each dimension.

Information

Battery Packs

- Battery Packs are available across all ranges and are required if your room design means you intend to locate your furniture in the centre of a room/where a plug socket is not easily accessible.
- Please ensure you specify this when ordering, your store colleague will discuss this with you.

Delivery

- Your furniture will be delivered to you within 9-11 weeks.*

Guarantees

- In the unlikely event that you experience any issues with your furniture, they are protected by the following guarantees.
- The wooden frame and the spring system are guaranteed for a period of 10 years from the date of purchase.
- Leathers, fabrics, sewing, foam and mechanisms are covered for 2 years.

Showroom Displays

Our beautiful new Nicoletti Collection is on display in selected showrooms, please call to check for availability before you travel.

Call 01924 507050 to check availability or scan the QR code to find your local showroom.



Guardsman 5 Year Care Package.

Our Guardsman Furniture Care Package has been improved to include additional HSL Care+ service benefits exclusive to HSL customers including mechanism cover on recliners. To find out more, please ask one of our friendly Comfort Specialists over the phone or in one of our showrooms.

Fabric furniture protection

Guardsman Fabric Care Kit – **£35**

First seat + Guardsman Fabric Care Kit – **£80**

Additional seat – **£45**

Leather furniture protection

Guardsman Leather Care Kit – **£35**

First seat + Guardsman Leather Care Kit – **£85**

Additional seat – **£50**

*Subject to seasonal changes, please ask an in-store colleague for more information.

Whilst every care is taken to ensure that the information contained in this publication is correct, no legal responsibility can be accepted for any inaccuracy. The company reserves the right to alter or modify the information contained herein at any time in the light of technical or other developments. Fabrics and leathers: patterns and colours may vary slightly from those shown.



Stressless



himolla



GIUSEPPE NICOLETTI
Exclusively for HSL



HSL

Feel Good Furniture
Experts since 1968

Call 01924 507050

Visit hslchairs.com

HSL0023-V1-0325